

Experimental searches of neutrino anomalies.

Feb. 18th, 14:40 - 15:10

(Venice NeuTel 2021)

Neutrino related anomalies ?

- Several anomalies have been collected for two decades in the neutrino sector suggesting the existence of some additional new related states beyond an ordinary 3-flavour mixing picture
- **anti- ν_e appearance** in the accelerator LSND experiment; Reaction is **anti ν_e -e** to **$e^{++}n$** with n captured by a p; **$n + p$ into $d + \gamma$** .
- **ν_e disappearance**: SAGE, GALLEX experiments with Mega-Curie sources and observed/predicted rate $R = 0.84 \pm 0.05$;
- **anti- ν_e disappearance** of near-by nuclear Reactor experiments and rate $R = 0.934 \pm 0.024$
- recent observation of sterile neutrino oscillations by the **NEUTRINO-4 experiment**.

The LSND Anomaly

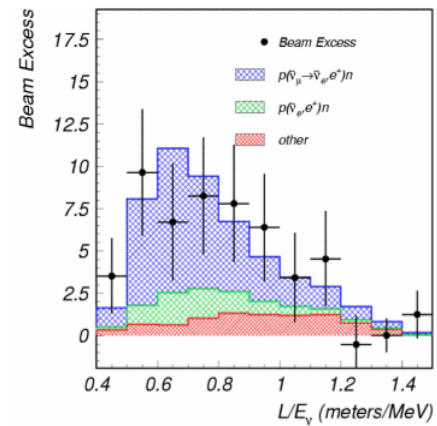
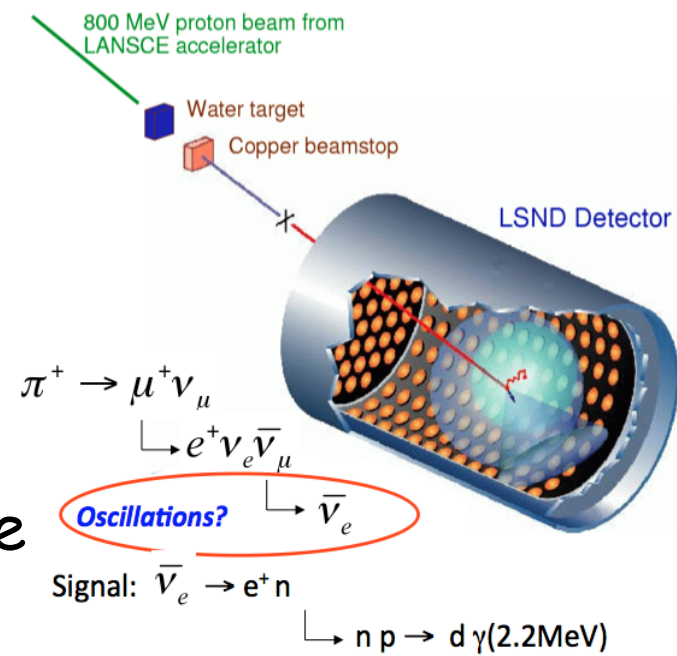

Saw an excess of $\bar{\nu}_e$: $87.9 \pm 22.4 \pm 6.0$ events.

With an oscillation probability of $(0.264 \pm 0.067 \pm 0.045)\%$.

3.8 σ evidence for oscillation.

The NEUTRINO-4 experiment

- The experiment has studied the possible observation of neutrino produced oscillations by an additional sterile neutrino as a function of L/E , with L the distance travelled (m) and E energy (MeV) by an incoming anti ν -e on a proton.
- At 8 m from the 90 MW Reactor core of $35 \times 42 \times 42 \text{ cm}^3$, one can record about 300 anti ν -e events/day with 1 m^3 of liquid scintillator. At a typical 9 meter distance, the neutrino energy is 9 MeV for $L/E = 1$ and 3.6 MeV for $L/E = 2.5$.
- The reaction is fitted according to the following form

$$P(\bar{\nu}_e \rightarrow \bar{\nu}_e) = 1 - \sin^2 2\theta_{14} \sin^2 \left(1.27 \frac{\Delta m_{14}^2 [\text{eV}^2] L [\text{m}]}{E_{\bar{\nu}} [\text{MeV}]} \right)$$

- where $E_{\bar{\nu}}$ is anti-neutrino energy in MeV, L the distance in meters, Δm_{14}^2 is difference in eV^2 between square masses of electron and sterile neutrinos, θ_{14} is mixing angle between electron and sterile neutrinos.

NEUTRINO-4 reactor signal

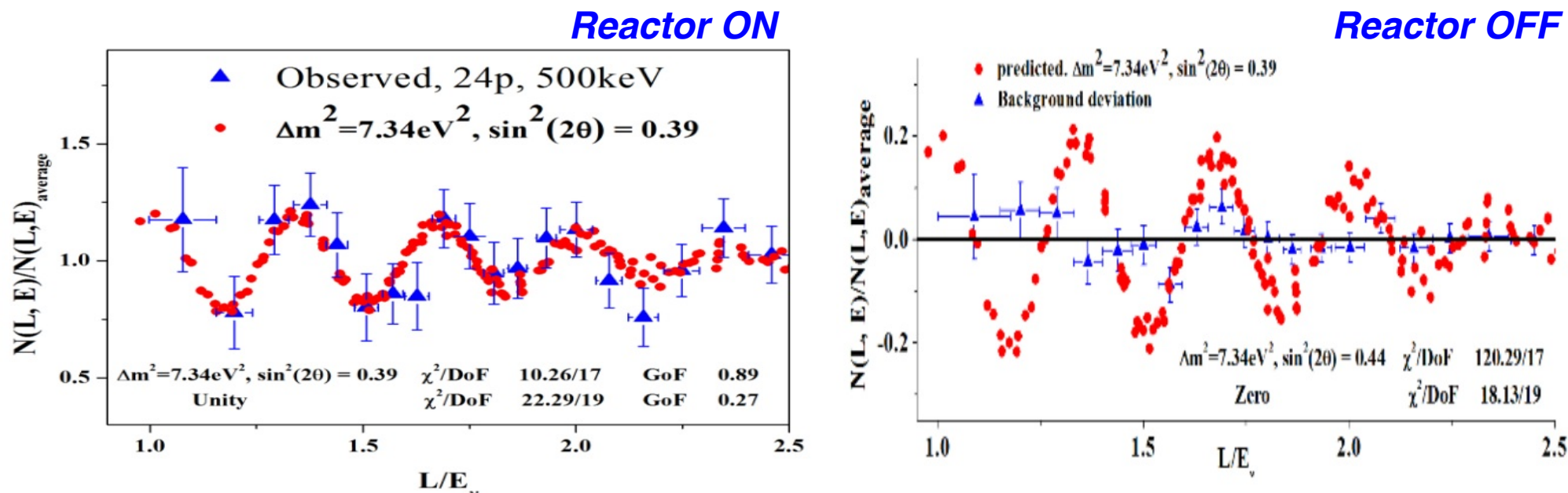

- Data has been collected for 3 years until June 2019, followed by background measurements until January 2020: 720 days reactor "on" and 417 days reactor "off", with 87 reactor cycles.

- The difference ON-OFF is 223 events per day in the range from 6.5 to 9 meters. The signal/background ratio is 0.54.

- The obtained value of the difference between the masses of the electron and sterile neutrinos is $\Delta m_{14}^2 = 7.26 \pm 0.13 \text{ stat} \pm 1.08 \text{ syst} \Rightarrow 7.25 \pm 1.09 \text{ eV}^2$ and the angle θ_{14} parameter $\sin^2(2\theta_{14}) = 0.26 \pm 0.08 \text{ stat} \pm 0.05 \text{ syst} \Rightarrow 0.26 \pm 0.09$. Lower probability satellite peaks are also observed at other masses.

Main result

- The result on an expanded scale in terms of SD (σ)
- The energy intervals of 500 keV corresponding to the energy resolution of the detector give $\chi^2/\text{DOF} = 17.1/17$, compared with $\chi^2/\text{DOF} = 30/19$ for the version without oscillations.

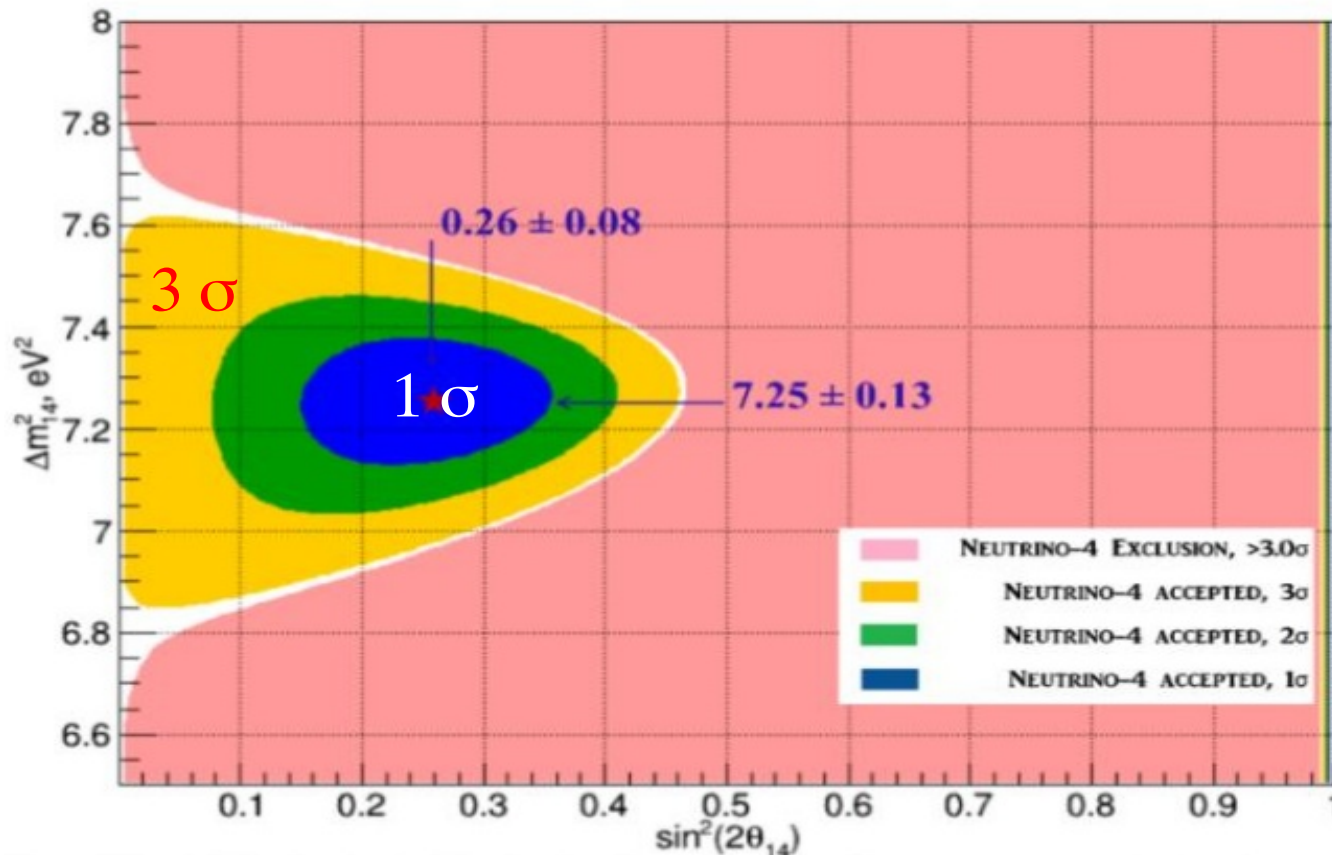

Main background

- The electron anti-neutrino signal is $\bar{\nu}_e + p \rightarrow e^+ + n$ followed by second delayed step with n captured by gadolinium
- **Fast neutrons** emitted outside the detector in interactions of **high energy cosmic ray muons** with matter around the detector become the main source of the background.
- The fast neutron background is $n + p \rightarrow p + n$ with neutron also captured by gadolinium

Neutrino event

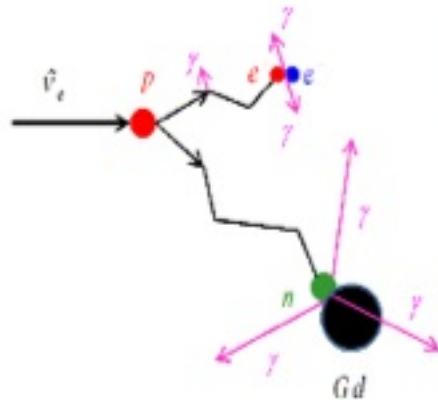

Background event

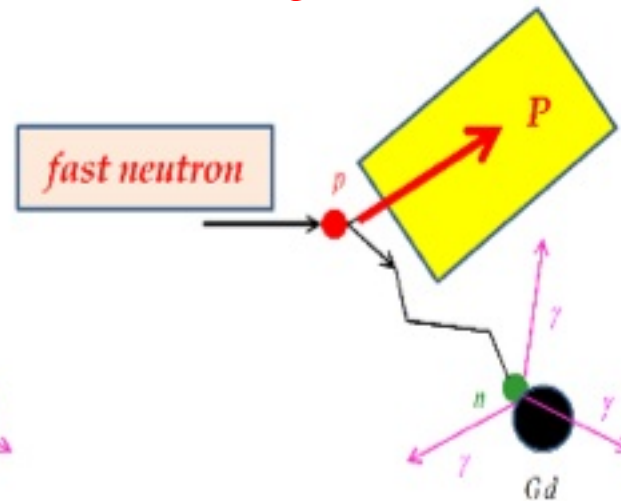

Summary

- Comparison of results of the NEUTRINO-4 and experiments STEREO and PROSPECT

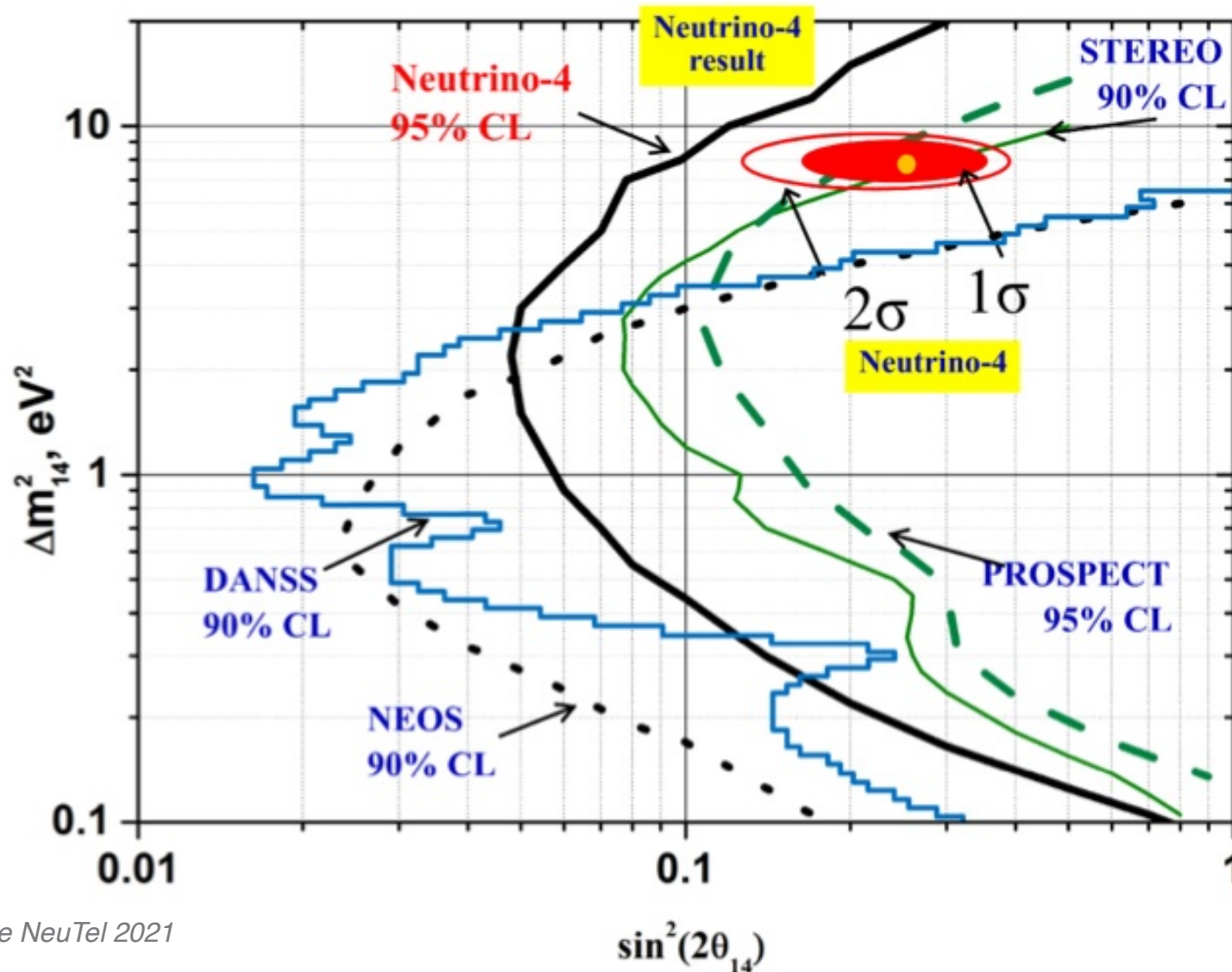

A new, powerful detection technique initiated at CNGS

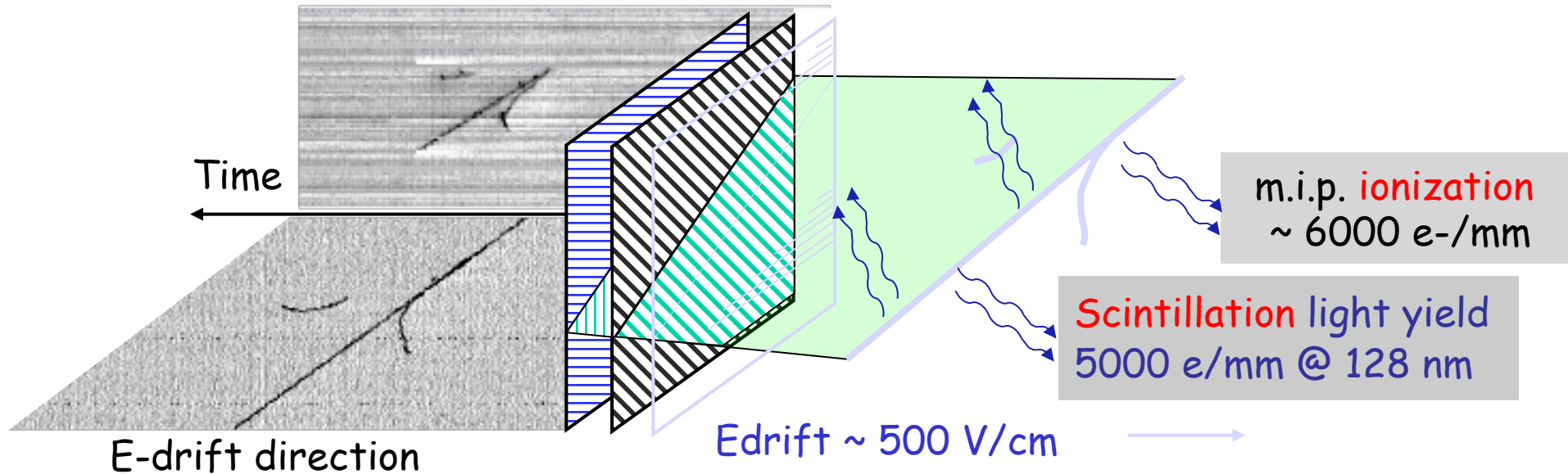

Drifting electrons are moving to transparent wire arrays oriented in different directions, where signals are recorded.

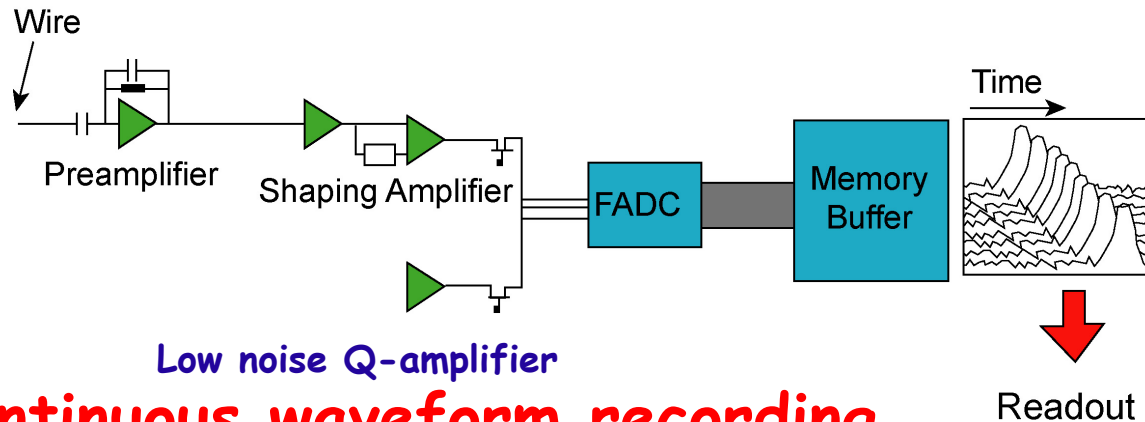

Continuous waveform recording

- High density
- Non-destructive readout
- Continuously sensitive
- Self-triggering
- Very good scintillator: T0

Non destructive, multiple charge readout

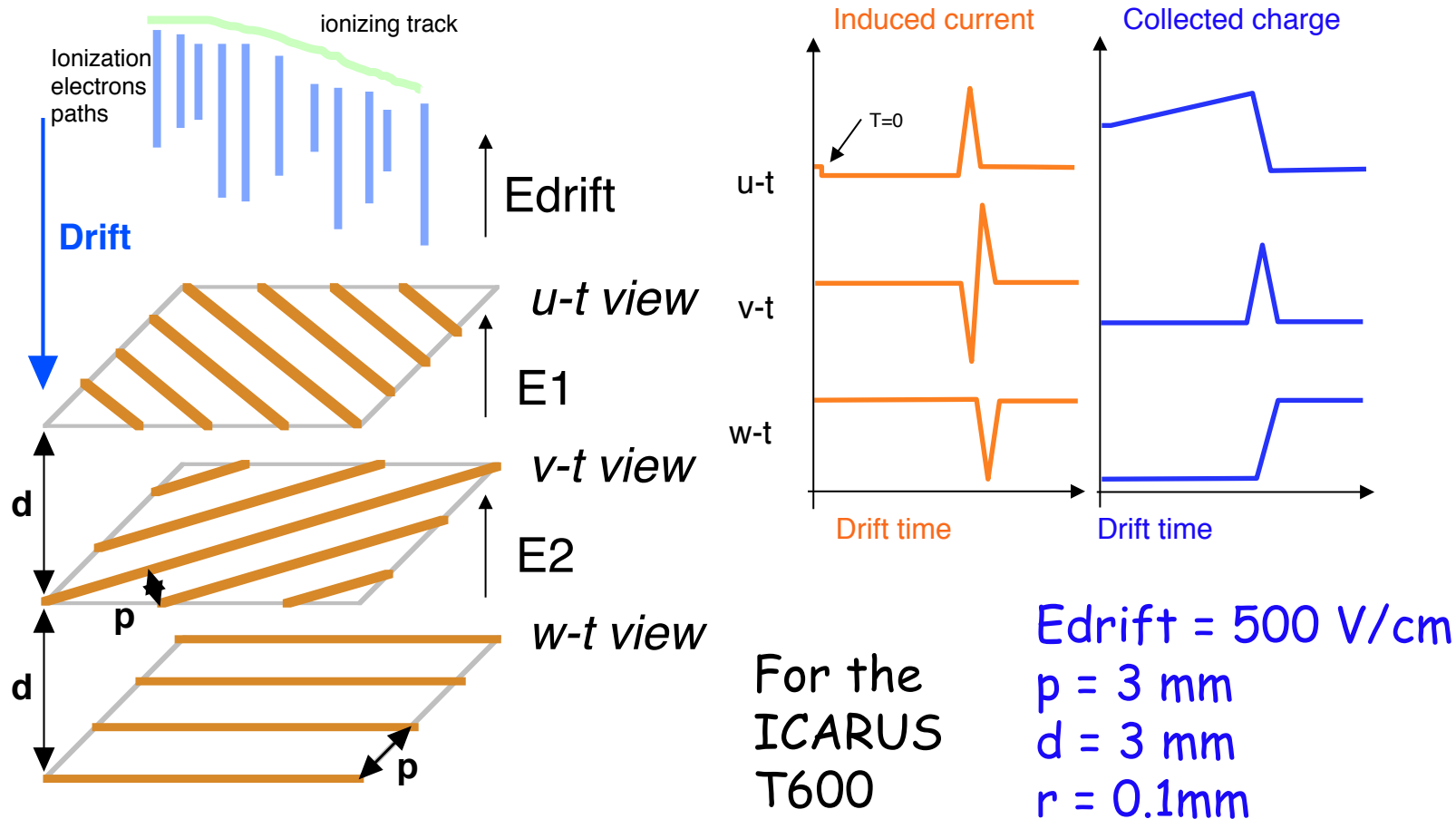

- At FNAL's shallow depth, the T600 will require two additions:
 - 3 m concrete overburden to mitigate the c. rays background,
 - Particles entering the detector must be removed with a Cosmic Rays Tagging (CRT) around the full LAr volume

3 D particle Identification ($k^+ \rightarrow \mu^+ \rightarrow e^+$) at CNGS

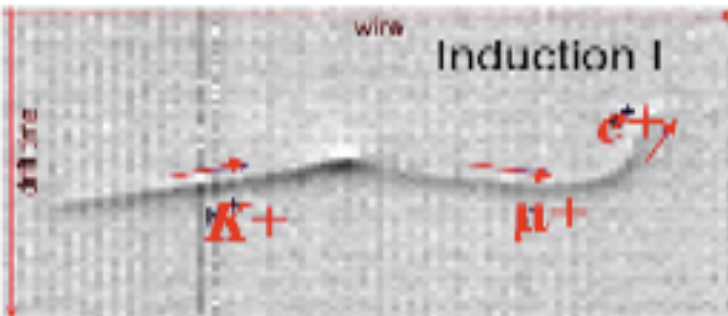

ICARUS EVENT

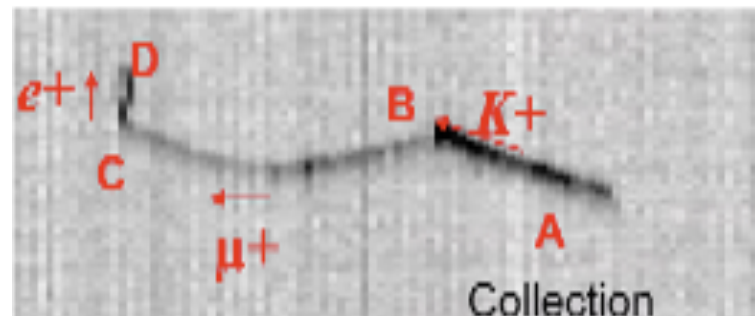

$$K^+ [AB] \rightarrow \mu^+ [BC] \rightarrow e^+ [CD]$$

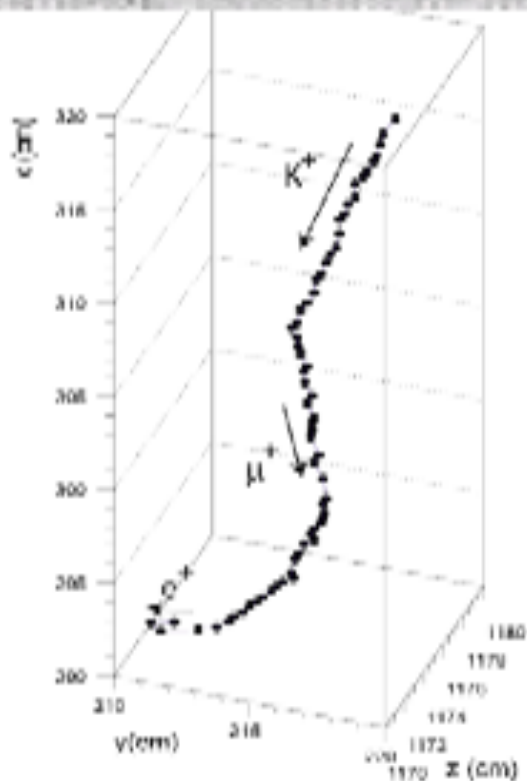

Efficient, low mis-identification, due to precise 3D reconstruction, dE/dx , range measurement

- stopping power
- recognition of secondary particle production after decay interaction

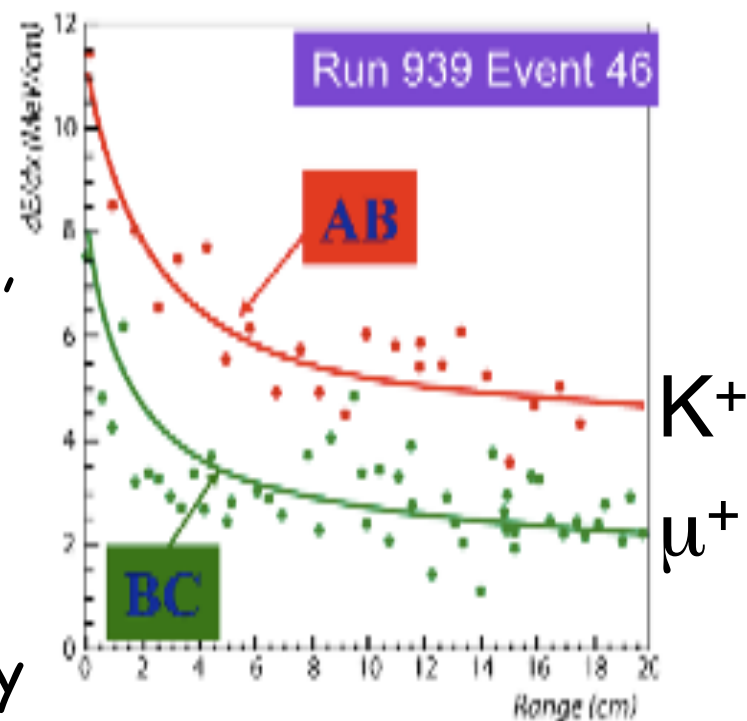

Measurement of muon momentum via multiple scattering

In absence of a magnetic field, the initial μ momentum may be determined through the reconstruction of multiple Coulomb Scattering (MS) in LAr

RMS of θ deflection of μ depends on p , spatial resolution σ and track segmentation

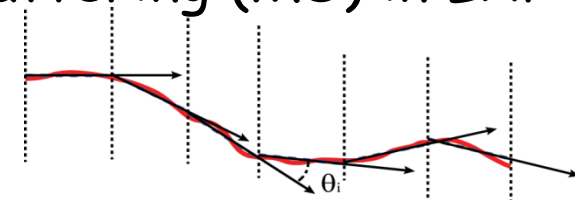

$$\theta_{RMS} \div \frac{13.6 \text{ MeV}}{p} \sqrt{\frac{l}{X_0}} \oplus \frac{\sigma}{l^{3/2}}$$

Method tested on **~103 stopping μ 's** from CNGS ν interactions in upstream rock, comparing **PMS** measured by MS with the corresponding calorimetric **PCAL**

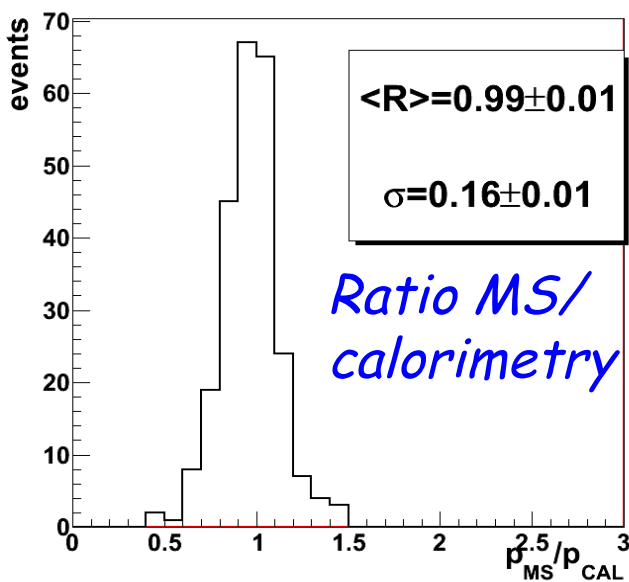

μ track length: $> 5m$
Used length: $4m$

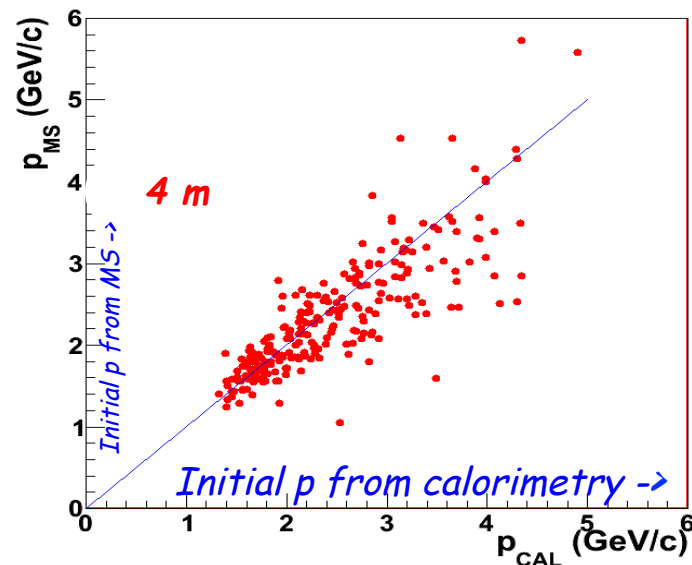

~16% resolution has been obtained in the 0.4-4 GeV /c momentum range of interest for the future short/long base-line experiments

Neutrino layouts at Fermilab

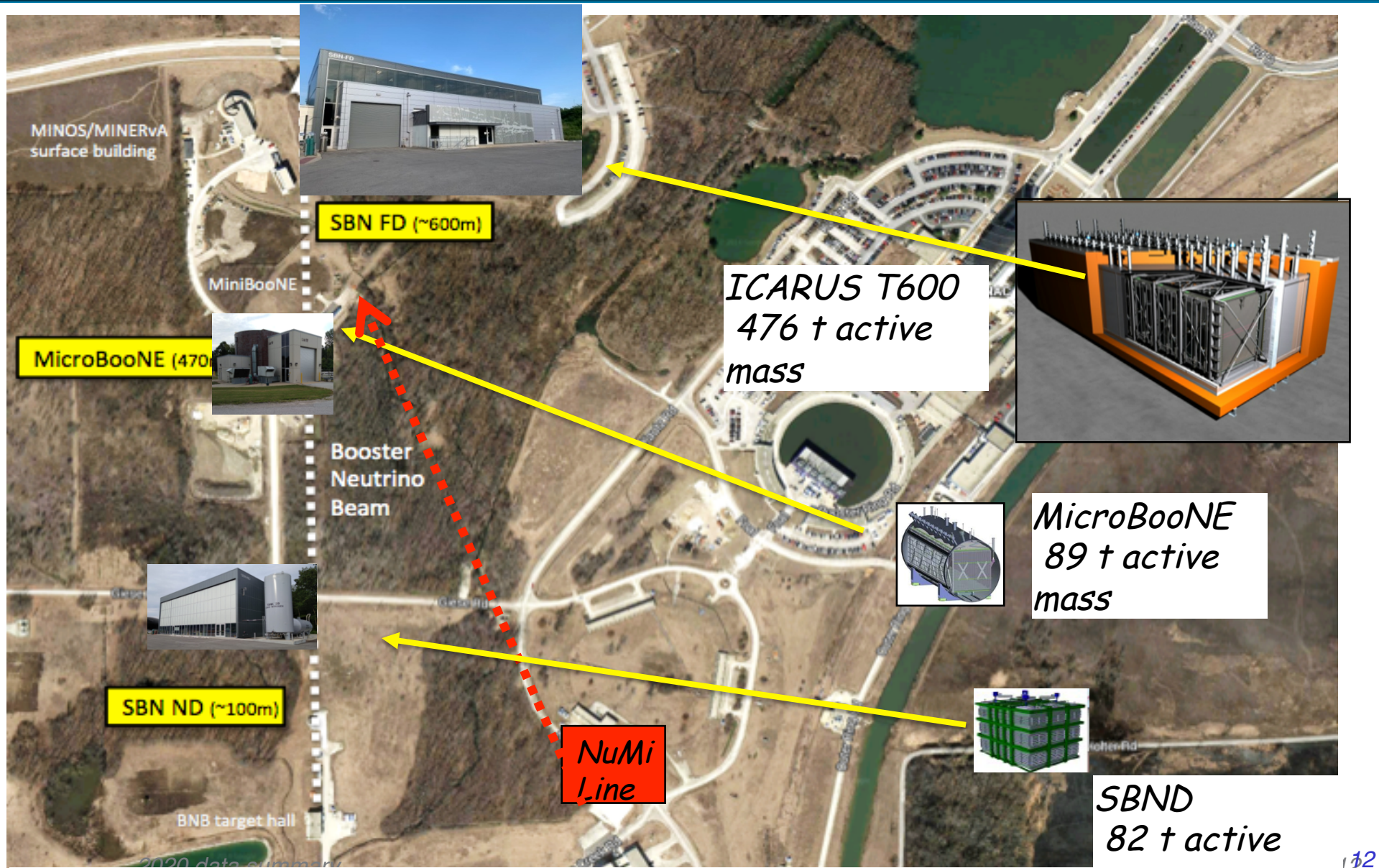

ICARUS T600 will collect also ~3 GeV ν_e NuMI Off-Axis:)

Similarities between NEUTRINO-4 and ICARUS

- ICARUS at the Booster (1) and at the NUMI (2) have remarkable similarities to NEUTRINO-4. We should be able to settle the NEUTRINO-4 prediction both in the ν - μ with the Booster and ν - e with NUMI.
- The Booster at about 600 m from the target can be directly compared to NEUTRINO-4 with a target of 42 cm followed by the detector between 6 and 12 m. with the ν - μ collected with ~ 100 times the energy. The number of Booster events with 1.6 μ s spill, $5 \cdot 10^{12}$ pot/spill, 5 Hz repetition rate are 12'800 ev/day of which $\sim 7'800$ ev/day are due to cosmic rays.
- The NUMI off-axis proton beam is located at ~ 700 m of distance from ICARUS and at an off-axis angle of 6 degrees. For 1 year with 0.75 Hz NUMI repetition rate and spills of 6×10^{13} ppp we expect for positive (negative) focussing 4.64×10^5 CC events/y (3.78×10^5 CC events/y).

The analysis procedure for the early ICARUS data

- The proposed early search will be limited to the observation of the **CC quasi elastic processes** $\nu-\mu + \text{neutron} \rightarrow \text{muon} + \text{proton}$ for Booster and $\nu-e + \text{neutron} \rightarrow \text{electron} + \text{proton}$ for NUMI.
- Only events with only one and well separated sizeable PMT's fast signal during the duration of the $t = 0$ burst will be retained.
- Initial, **automatic event** selection is based on:
 - (1) a sum of **signals from the PMT 's** above a threshold and
 - (2) the absence of **signals from the CRT** over its 4π surface, occurring a few ns after or before the earliest of the PMT signals within the event.
- Events missed by the CRT detection inefficiency are also kept.
- This simple fast signal selection will reduce of about one order of magnitude the events initially in excess of 10:000/day.
- Next the 3-D 1 ms long image will be displayed **only for these resulting triggers.**

3-D 1 ms long image

- All connected vertices of two joining tracks will be searched inside the whole 1 ms image — one for a high dE/dx stopping proton and the other either for a stopping muon (for Booster) or a single electron showering (for NUMI).
- All other kinds of tracks visible in the the 3-D 1 ms long image and escaping events will not be considered.
- The position of the pattern in the visual 1 ms display will coincide with the one from the PMT's **only for $t = 0$ patterns**. This is why the search for patterns in the visual image should cover the full visible area.
- The kinematics of the finally recorded vertices will be compared with the predictions of the NEUTRINO-4 experiment, confirming the absence of these events for a test sample of out of beam-time recorded events.

Automatic detection of a proton stopping end track

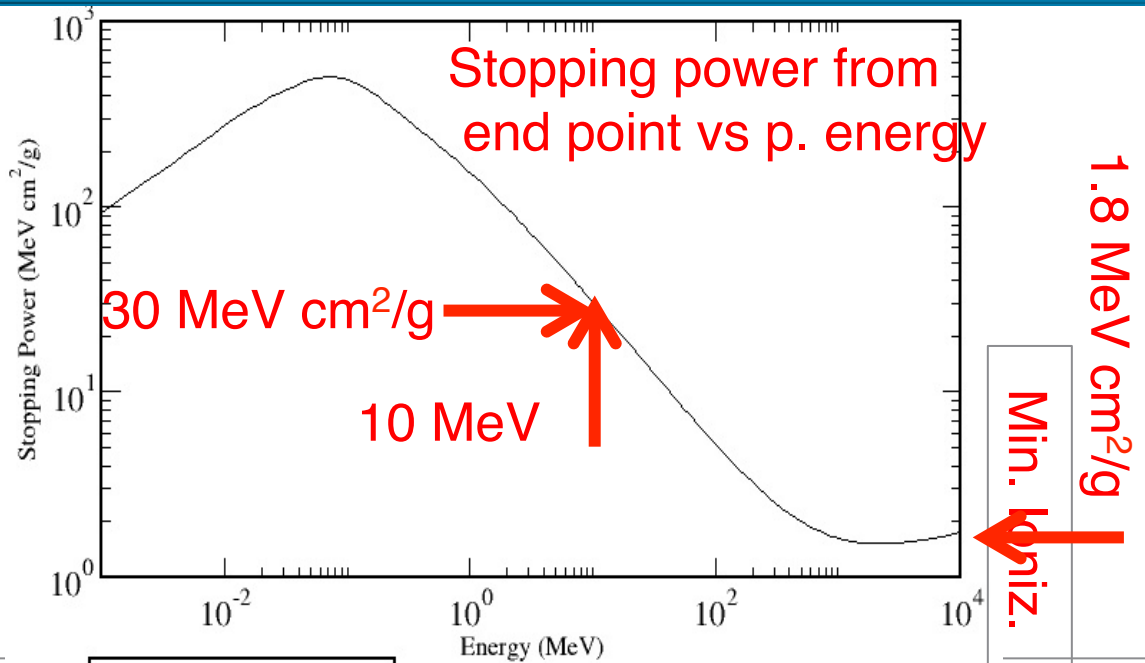
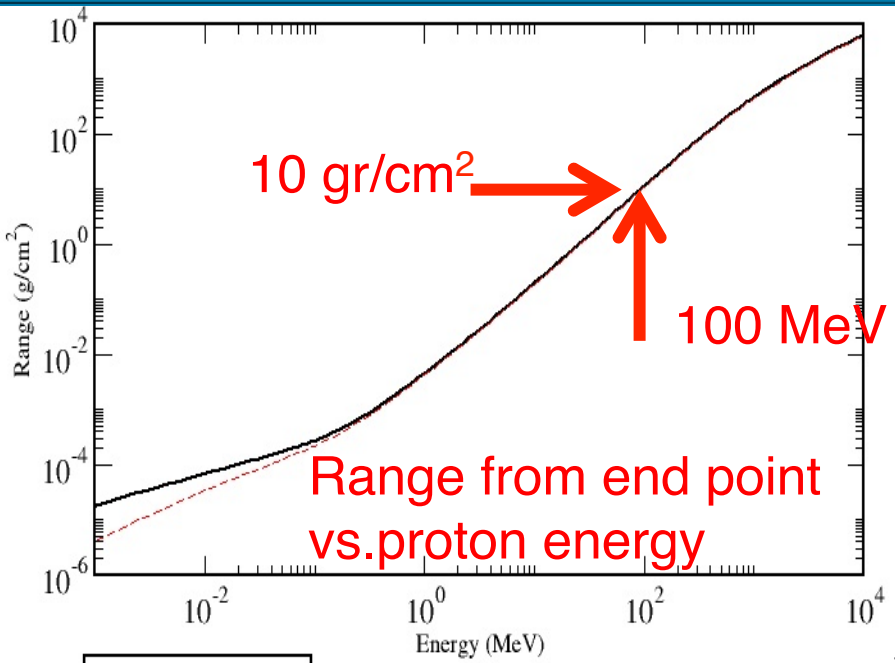

- The search for 1 ms displays will be started by the instrumental detection of end point **proton 3D tracks with its above features.**
- At an observed proton track, one must require an "attached" minimum ionizing track, either a muon for Booster or an electron for NUMI. No distinction is made between on-time and off-time
- Validity of the automatic process will be verified by comparing it with some events scanned visually.

General expectations for the future SBN data taking

- The data taking is based on a future and definitive demonstration of the 2.8σ L/E decay pattern observed by the NEUTRINO-4 experiment.
- The experiment will be primarily dedicated to the following *four main observations*:
 - 1.- Detection of the *ν -mu disappearance* in the Booster beam with the ICARUS detector
 - 2.- Similar detection of the *ν -e disappearance* in the NUMI off-axis k beam
 - 3.- Comparison between the ICARUS at 590 m and SBND at 110 m from the target in the Booster beam to test validity of the 3-1 model and *appearance of the ν -e signal*.
 - 4.- Confirmation of a sterile mass for the *effective masses of the light active neutrino*. The $m_{\nu_e}^{\text{eff}} \sim \text{sqrt}[m_4^2 |U_{e4}|^2]$ and $m_{\nu_\mu}^{\text{eff}}$ and $m_{\nu_\tau}^{\text{eff}}$ may be compared with future direct experiments, f.i. with next KATRIN.

1.- Booster beam

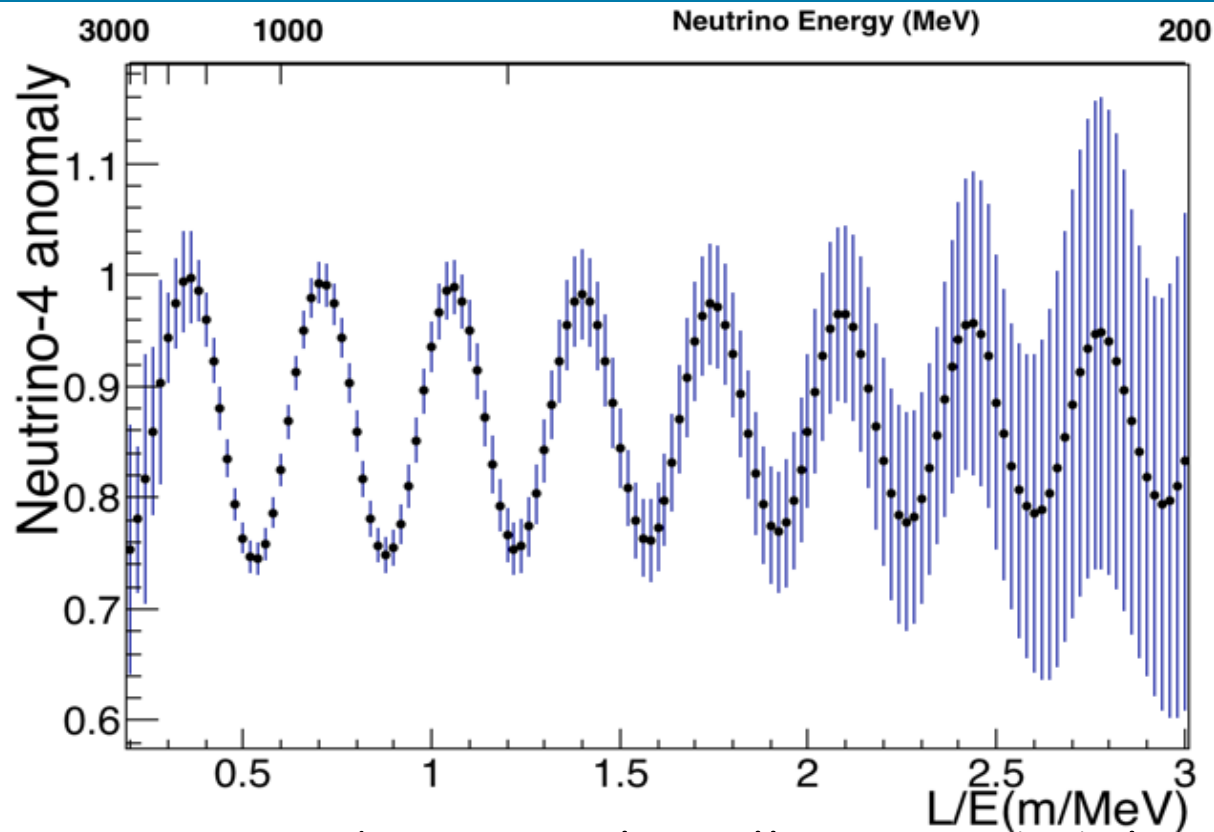

- The figure represents the survival oscillation probability in the presence of the Neutrino-4 anomaly.
- The calculation has been performed considering **a 3 years long run** (~117k $\nu_{\mu}CC$ QE contained events) for steps of $\Delta(L/E) = 0.02$ and considering the best fit of NEUTRINO-4 parameters $\Delta m^2_{N4} = 7.25 \text{ eV}^2$ and $\sin^2 2\theta_{N4} = 0.26$ (only statistical errors are reported)

Results already after 3 month, with $L_\mu > 50$ cm

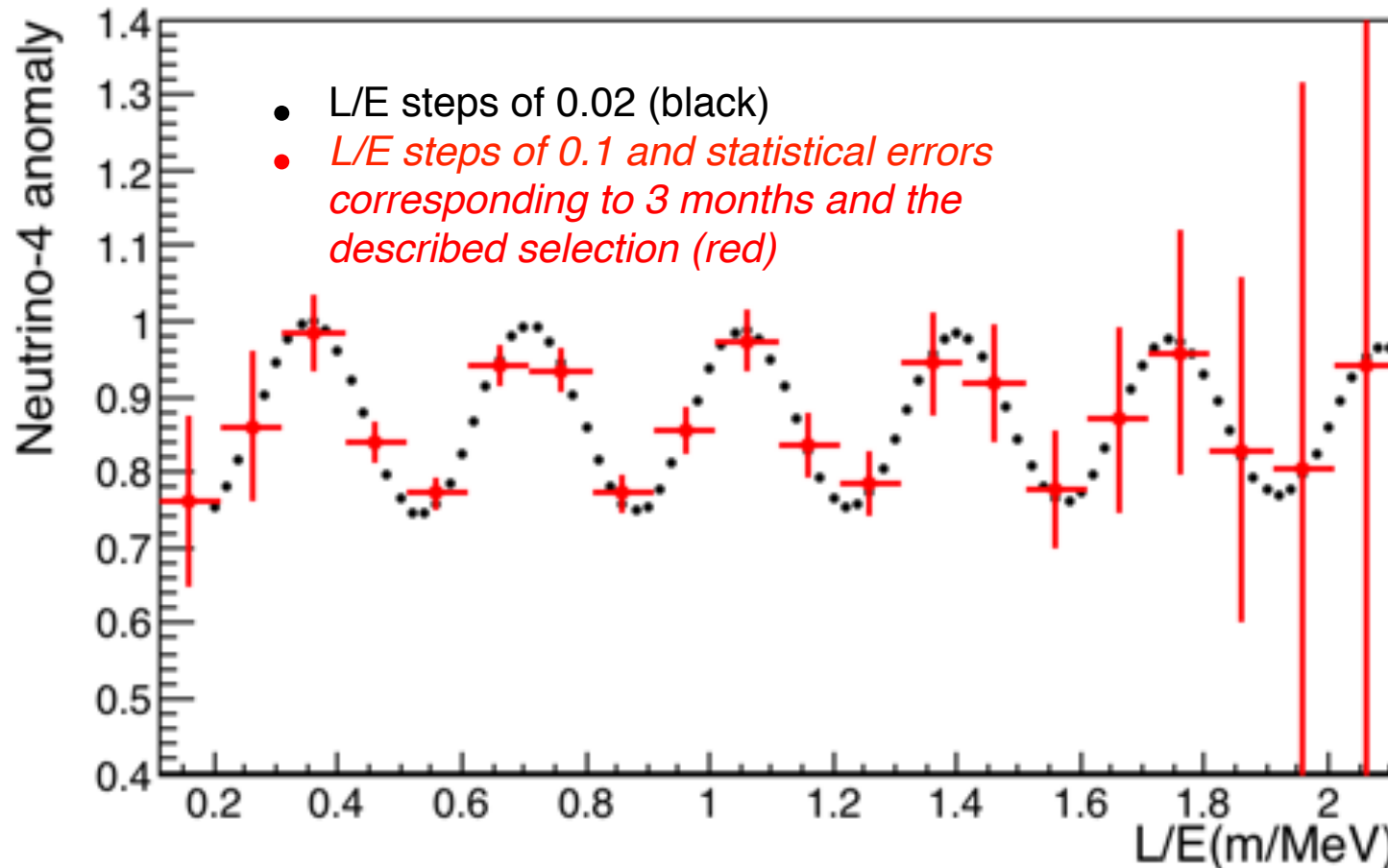

- The additional request on the muon length $L_\mu > 50$ cm for a better μ identification has been also included (~ 8600 events expected in 3 months)
- It removes all the neutrino events with $E_\nu < 300$ MeV and reduces the statistics at low ν energy, increasing the statistical errors at high L/E

2.- NUMI results

- The NUMI off-axis proton beam is generated at ~800 m of distance from ICARUS and at an off-axis angle of 6 degrees)
- Kaons are primarily in the off-axis NUMI, leading to a much larger participation of the ν -e signal, with a neutrino energy distribution similar to the Booster beam case.
- One year at 0.53 Hz rate and 4×10^{13} ppp and an exposure to 6×10^{20} pot corresponds to 1 CC event every 32 spills for positive and to 1 event for 40 spills for negative focussing .
- The ratio ν -e CC/ ν - μ CC = 17.2 k/388 k = 4.4 % for positive focussing and about 50% are quasi-elastic.
- Reasonable fiducial cuts event brings the number of ν -e events to about 7300/year for positive focussing , sufficient to verify conclusively the NEUTRINO-4 observation as well with ν -e events already after few months of data taking.

2,- NUMI results – cont.

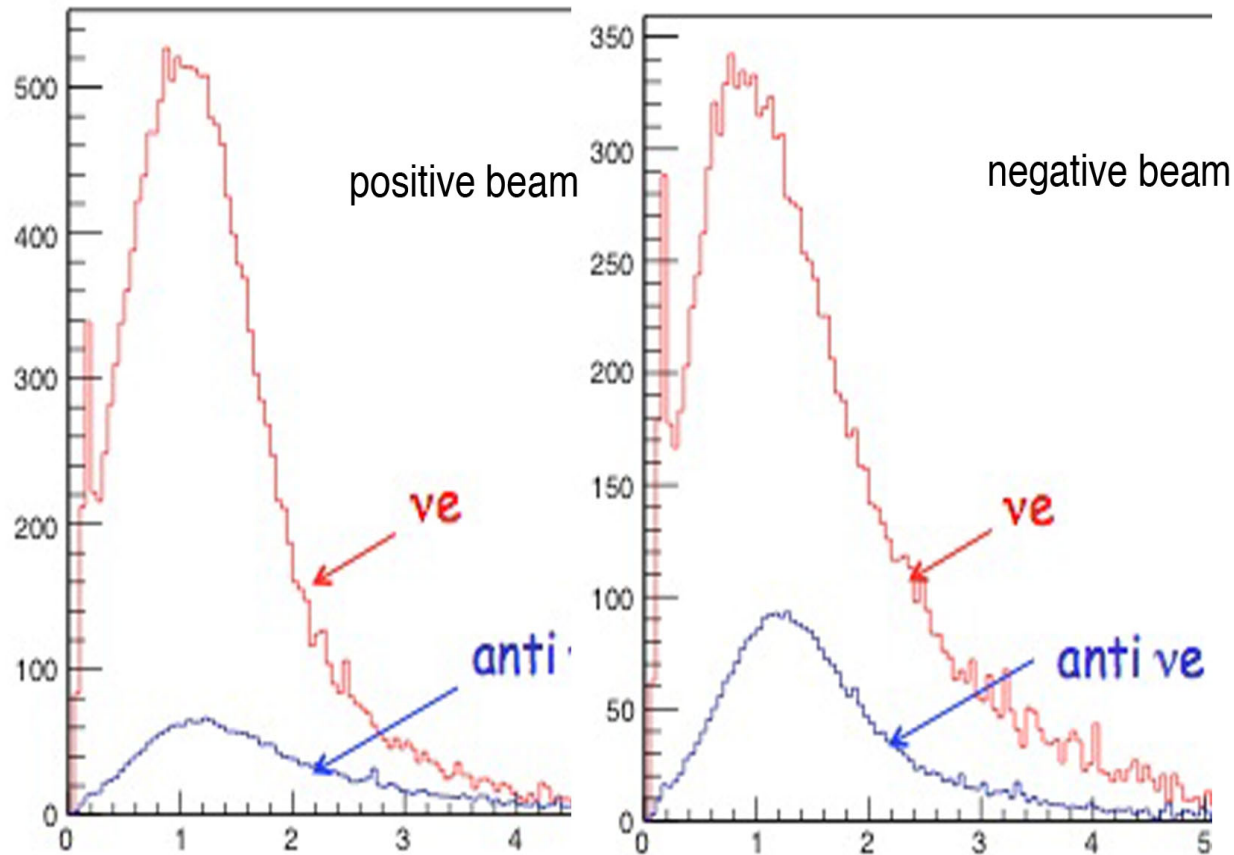

- CC rates of the off-axis NUMI beam to ICARUS for $M = 430$ ton and 6×10^{20} pot (one year @ 0.53 Hz repetition rate and $4 \cdot 10^{13}$ proton per pulse). Data on the left refer to CC Spectra for ν_e $\bar{\nu}_e$ positive focusing; data on the right are for negative focusing.

Summary of the procedure for the early ICARUS analysis

- The main purpose is the confirmation of the NEUTRINO-4 experiment with ICARUS in the ν - μ and ν - e channels.
- Analysis is initiated by the presence within the 1 ms visual signal of all higher ionization stopping tracks confirmed to be due to a proton. The line trajectory is reconstructed backwards from its highest ionization point.
- The other end of the "proton" must be attached either to a "muon" or of a singly ionizing electron departing at an angle.
- The activations of the CRT trigger and of the 3 m concrete shielding presumed at a later time do not modify the analysis procedure but only reduce the number of events to be studied.
- The V is reconstructed in 3D views and for contained events.
- The distribution following NEUTRINO-4 of $t L/E$ is plotted with E = the total energy of the V and L = the distance to the neutrino beam, searching for sterile neutrino oscillations.

MC event Run 5 SubRun 44 Event 64

- A clear q.e. ν_e event: $p + e$.

$$E_\nu = 1.34 \text{ GeV} \quad E_{\text{dep}} = 1.29 \text{ GeV}$$

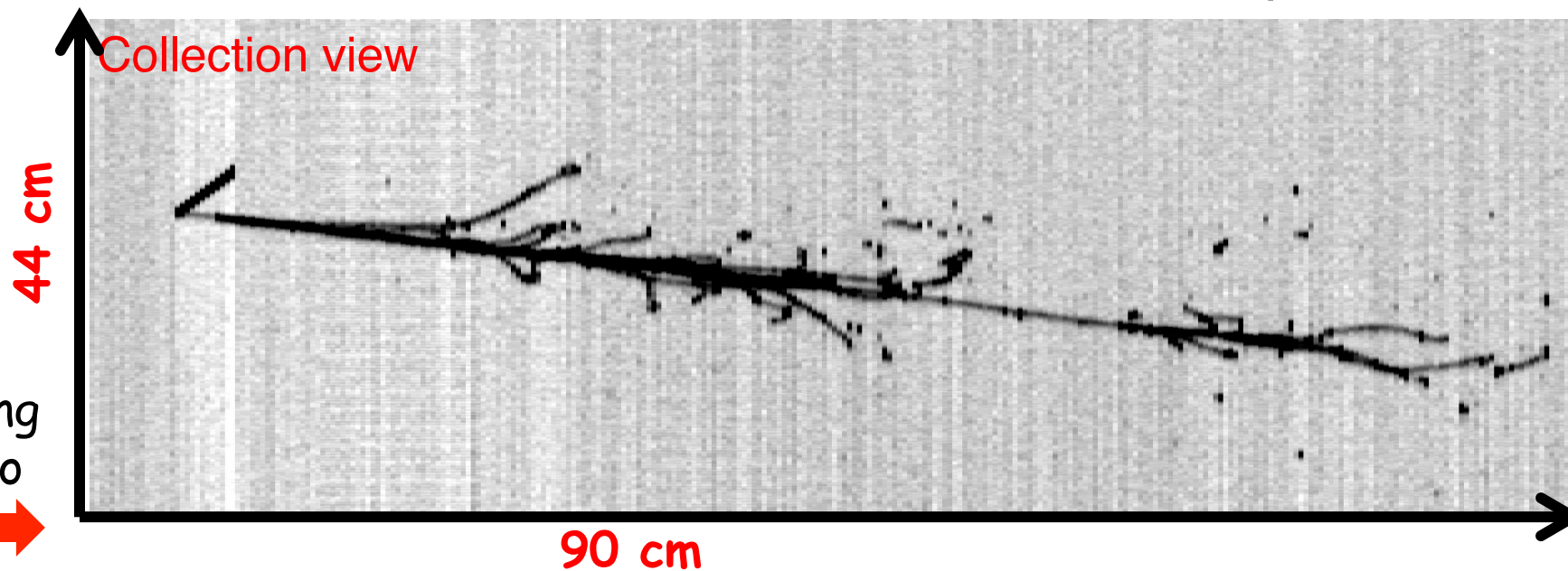

$$E_e = 1.21 \text{ GeV}$$
$$T_p = 93 \text{ MeV}$$
$$R_p = 7 \text{ cm}$$
$$T_p/R_p = 13.2$$

MeV/cm

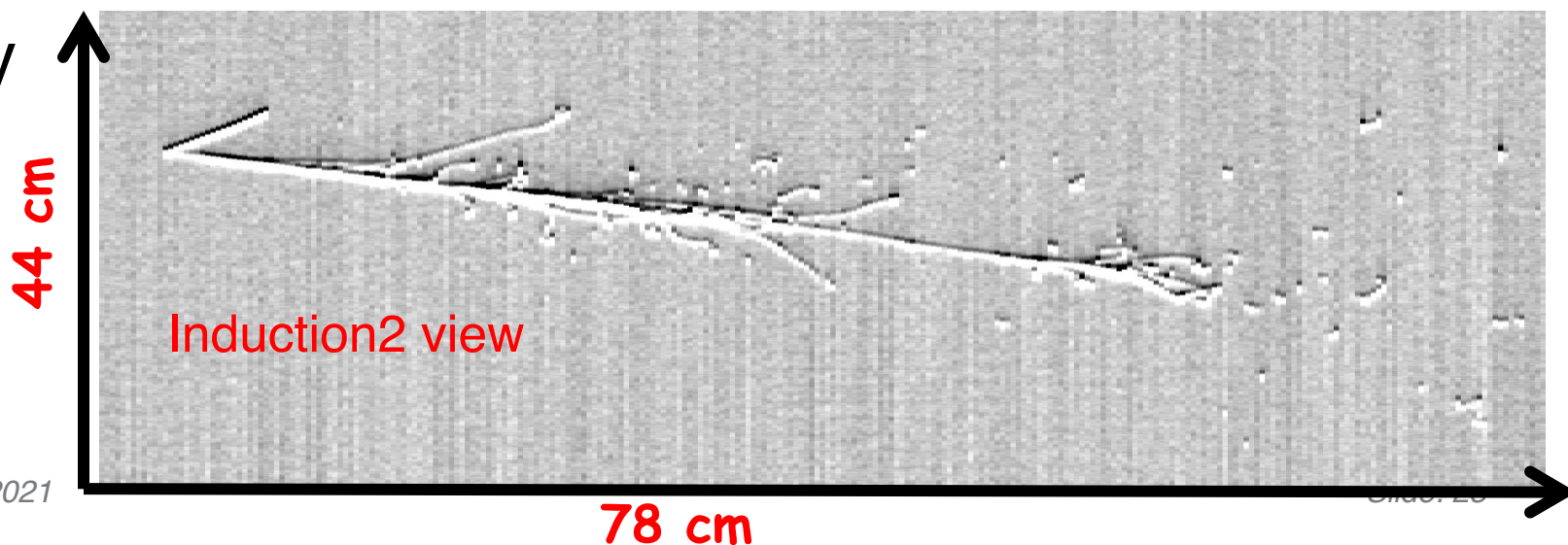

MC event Event 14

- A low energy q.e. $\nu\mu$ CC event $p + \mu$.

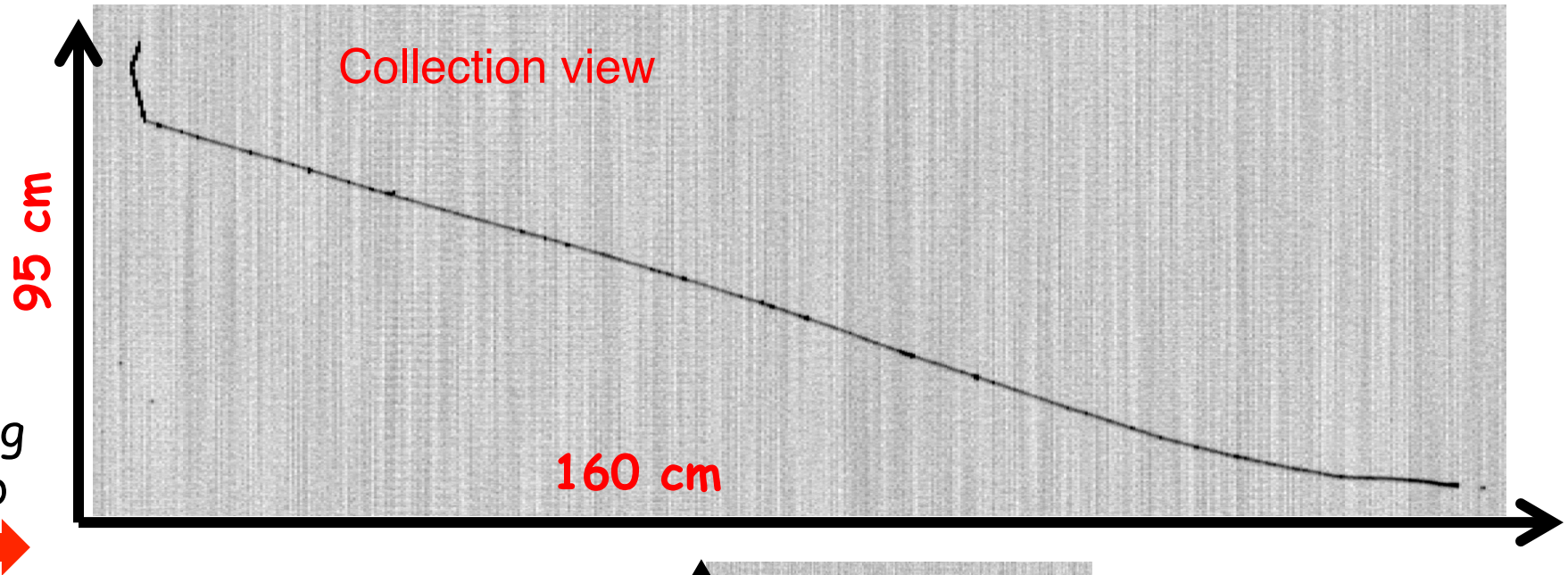

$$E_\nu = 0.74 \text{ GeV}$$
$$E_{\text{dep}} = 0.61 \text{ GeV}$$

To obtain the total neutrino energy we should include to the E_{dep} the mass of the muon

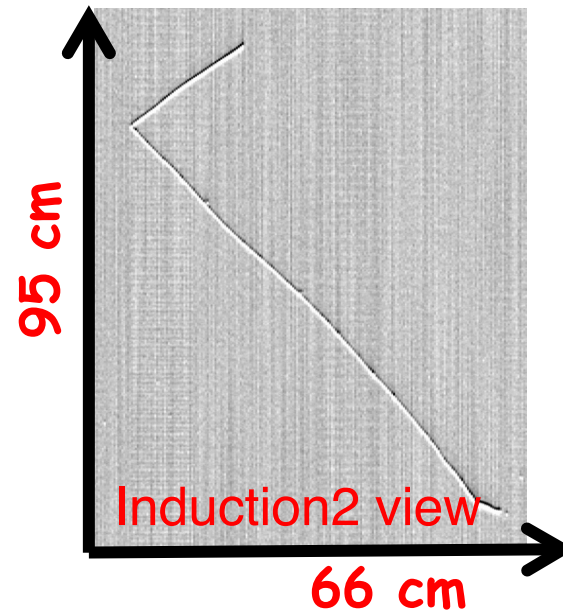

$$T_\mu = 0.4 \text{ GeV}$$

$$R_\mu = 166 \text{ cm}$$

$$T_p = 0.2 \text{ GeV}$$

$$R_p = 25 \text{ cm}$$

$$T_p/R_p = 8 \text{ MeV/cm}$$

$$T_\mu/R_\mu = 2.4 \text{ MeV/cm}$$

The ν_μ CC QE contained events with a muon track > 50 cm

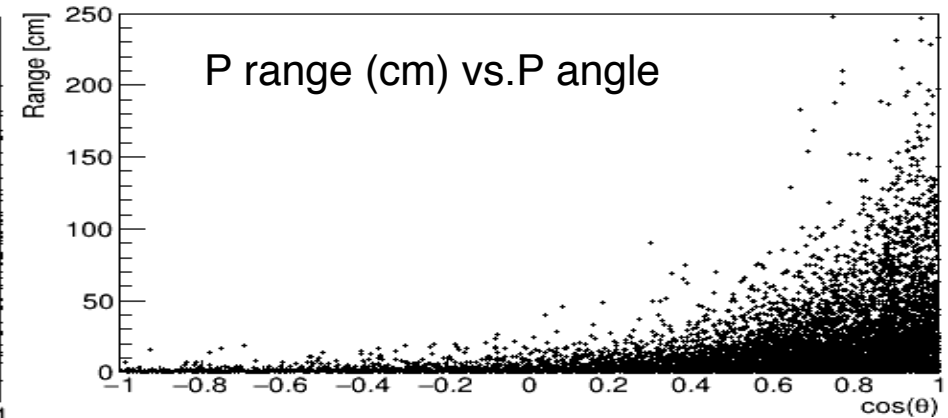
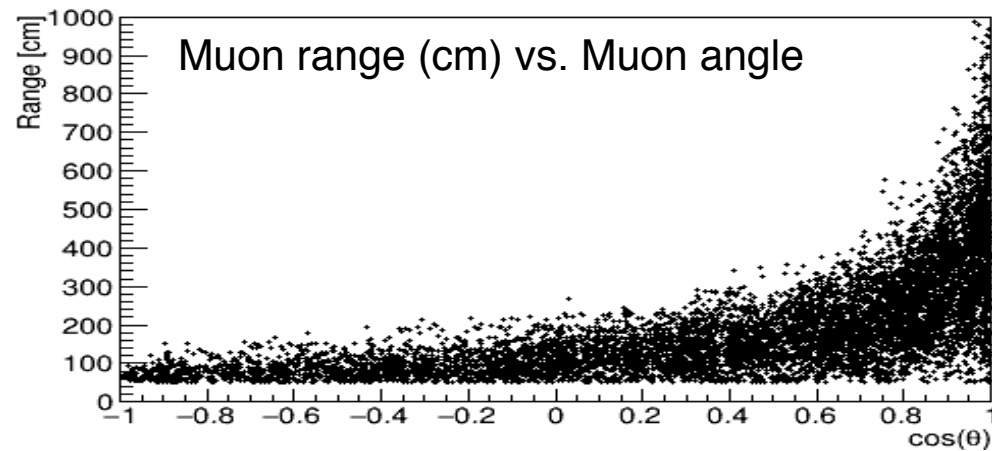
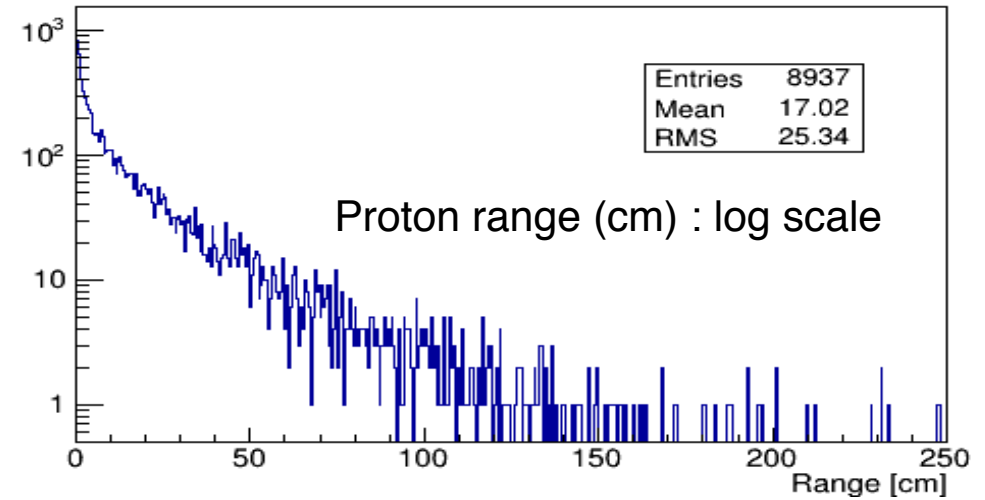
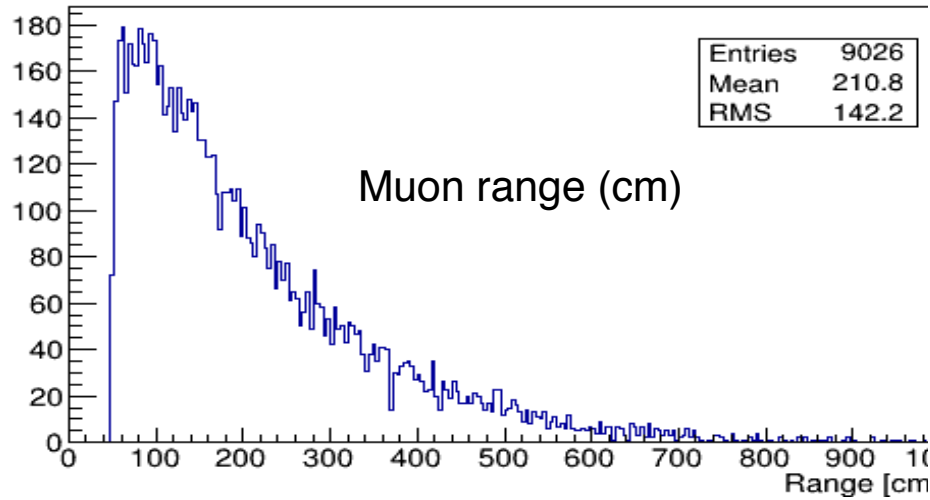

- In $\sim 1\%$ of the events have no proton produced
- In $\sim 8\%$ of the events, the proton range is below 0.5 cm

3.- Combined ICARUS and SBND appearance of ν - signal

- The structure of 3 + 1 neutrino model and representation of probabilities of various oscillations

$$\begin{bmatrix} \nu_e \\ \nu_\mu \\ \nu_\tau \\ \nu_s \end{bmatrix} = \begin{bmatrix} U_{e1} & U_{e2} & U_{e3} & U_{e4} \\ U_{\mu1} & U_{\mu2} & U_{\mu3} & U_{\mu4} \\ U_{\tau1} & U_{\tau2} & U_{\tau3} & U_{\tau4} \\ U_{s1} & U_{s2} & U_{s3} & U_{s4} \end{bmatrix} \begin{bmatrix} \nu_1 \\ \nu_2 \\ \nu_3 \\ \nu_4 \end{bmatrix} \quad \left| \begin{array}{l} |U_{e4}|^2 = \sin^2(\theta_{14}) \\ |U_{\mu4}|^2 = \sin^2(\theta_{24}) \cdot \cos^2(\theta_{14}) \\ |U_{\tau4}|^2 = \sin^2(\theta_{34}) \cdot \cos^2(\theta_{24}) \cdot \cos^2(\theta_{14}) \end{array} \right.$$

$$1.-> P_{\nu_e \nu_e} = 1 - 4|U_{e4}|^2(1 - |U_{e4}|^2) \sin^2\left(\frac{\Delta m_{14}^2 L}{4E_{\nu_e}}\right) = 1 - \sin^2 2\theta_{ee} \sin^2\left(\frac{\Delta m_{14}^2 L}{4E_{\nu_e}}\right)$$

$$2.-> P_{\nu_\mu \nu_\mu} = 1 - 4|U_{\mu4}|^2(1 - |U_{\mu4}|^2) \sin^2\left(\frac{\Delta m_{14}^2 L}{4E_{\nu_\mu}}\right) = 1 - \sin^2 2\theta_{\mu\mu} \sin^2\left(\frac{\Delta m_{14}^2 L}{4E_{\nu_\mu}}\right)$$

$$3.-> P_{\nu_\mu \nu_e} = 4|U_{e4}|^2|U_{\mu4}|^2 \sin^2\left(\frac{\Delta m_{14}^2 L}{4E_{\nu_e}}\right) = \sin^2 2\theta_{\mu e} \sin^2\left(\frac{\Delta m_{14}^2 L}{4E_{\nu_e}}\right)$$

predict ? ->

$$\sin^2 2\theta_{ee} \equiv \sin^2 2\theta_{14}$$

$$\sin^2 2\theta_{\mu\mu} = 4 \sin^2 \theta_{24} \cos^2 \theta_{14} (1 - \sin^2 \theta_{24} \cos^2 \theta_{14}) \approx \sin^2 2\theta_{24}$$

$$\sin^2 2\theta_{\mu e} = 4 \sin^2 \theta_{14} \sin^2 \theta_{24} \cos^2 \theta_{14} \approx \frac{1}{4} \sin^2 2\theta_{14} \sin^2 2\theta_{24}$$

3.-confirming the 3 +1 model jointly by ICARUS and SBNB

- Cancellations may occur between disappearance and appearance. There is an important difference between the original LSND and the future FermiLab programs.
- This is due to the fact that ν_e events are now produced both from a $R_{\nu\mu}(E)$ generated LSND $\nu\mu \rightarrow \nu_e$ effect and from a $R_{\nu e}(E)$ "intrinsic" ν_e source with about 0.5% of the muon rate.
- Attenuation, in analogy with the case of nuclear reactors, must occur also for the "intrinsic" beam produced ν_e source
- Therefore cancellation between this and LSND generated $\nu\mu \rightarrow \nu_e$ conversion are expected in the detected ν_e signal S_{ν_e} :
$$S_{\nu_e} = [R_{\nu\mu}(E)\sin^2(2\theta_{e\mu}) - R_{\nu e}(E)\sin^2(2\theta_{ee})]\sin^2(1.27\Delta m_{41}^2 L/E)$$
- where Δm_{41}^2 , the squared mass difference with respect to the fourth heavier neutrino is a common factor as a function of mass difference and L/E .

Examples of electron neutrino spectra

Giunti Laveder best fit:

$$\Delta m^2 \sim 1.5 \text{ eV}^2 ;$$

$$\sin^2(2\theta_{\mu\mu}) = 0.05 ;$$

$$\sin^2(2\theta_{ee}) = 0.1 ;$$

$$\sin^2(2\theta_{\mu e}) = 1.25 \times 10^{-3}$$

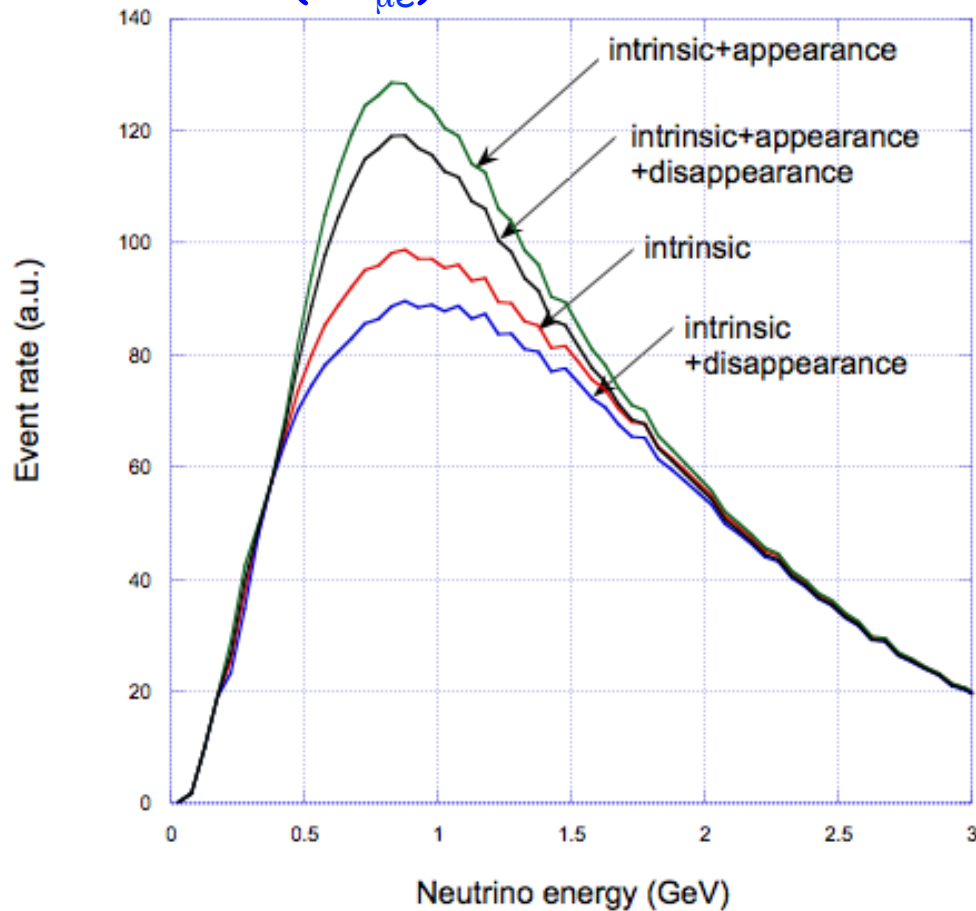

Extreme case of full cancellation

$$\Delta m^2 \sim 1.5 \text{ eV}^2 ;$$

$$\sin^2(2\theta_{\mu\mu}) = 0.016 ;$$

$$\sin^2(2\theta_{ee}) = 0.1 ;$$

$$\sin^2(2\theta_{\mu e}) = 0.4 \times 10^{-3}$$

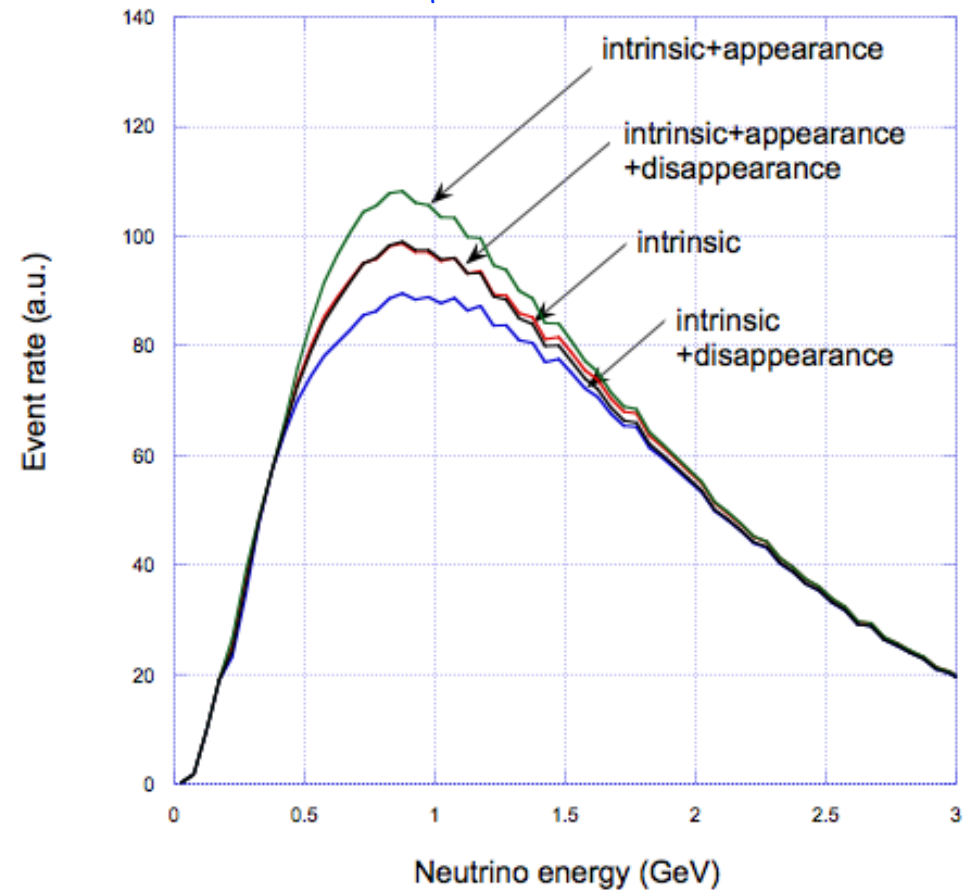

Electron recombination effects

- None of the electron recombination theories developed so far is fully successful in describing all the experimental data in liquid argon. Nevertheless, they provide the basis for its understanding and for all phenomenological approaches.
- The recombination effect has been already carefully studied by us and it is a very important process which needs to be further studied.
- There are several minor additives to the LAr which may modify this effect, transforming some of the produced light into additional ionization which could be useful also for the future FNAL programs.
- *The introduction of a dopant will be highly valuable for protons.*

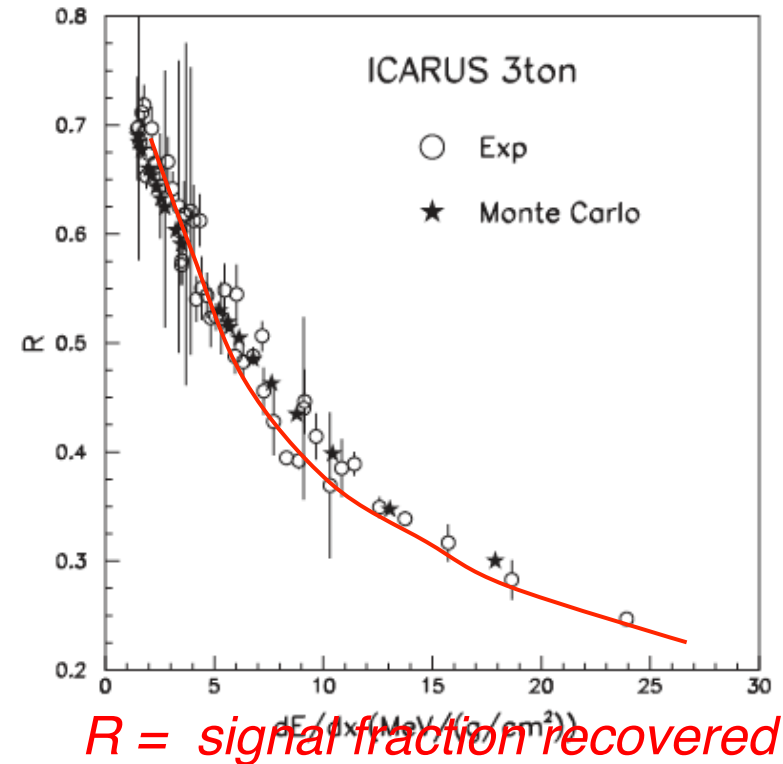

Doping with tetra-methyl-germanium (TMG)

- The nonlinear detector response may degrade the particle identification capability of the LAr-TPC.
- A possible solution to improve the linearity of the detector response is to introduce photo-sensitive dopants able to convert part of the scintillation light into additional free electron-ion pairs, thus enhancing the linearity as a function of the deposited energy density and electric field.
- We have chosen TMG as photo-sensitive dopant since:
 - TMG is not absorbed in the recirculation system
 - TMG can be easily purified (electron lifetime better than $10\ \mu\text{s}$ in pure TMG)
 - TMG has a large photo-absorption cross section of 62 Mbarn and has an acceptable quantum efficiency
- The performance of the detector is greatly improved and is remarkably stable in time
- TMG growth of +25% to +220% found from 1.6 to 32 MeV/cm.

Doping with tetra-methyl-germanium (TMG)

- Collected charge and deposited energy at an electric field of 200 V/cm and TMG concentration of 3.5 ppm for stopping muon and proton events.
- Time evolution at 300 V/cm during the LAr doping with TMG.

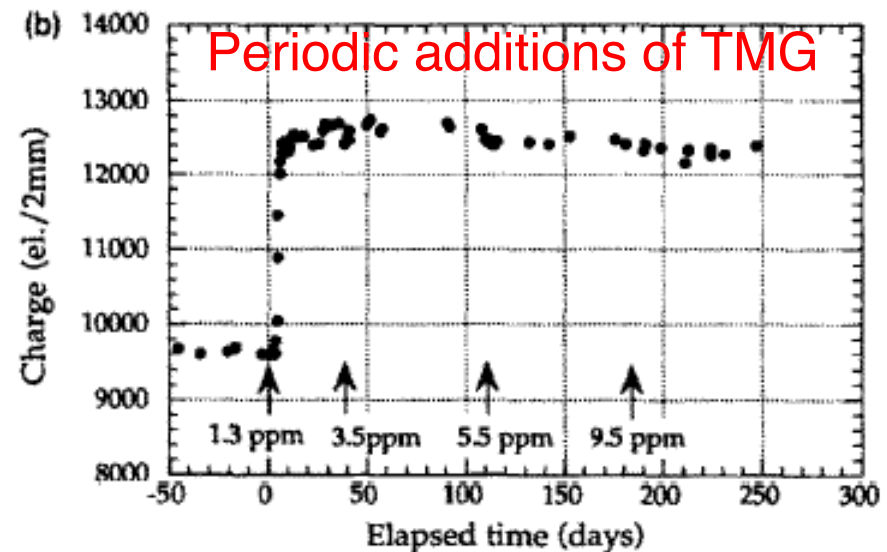
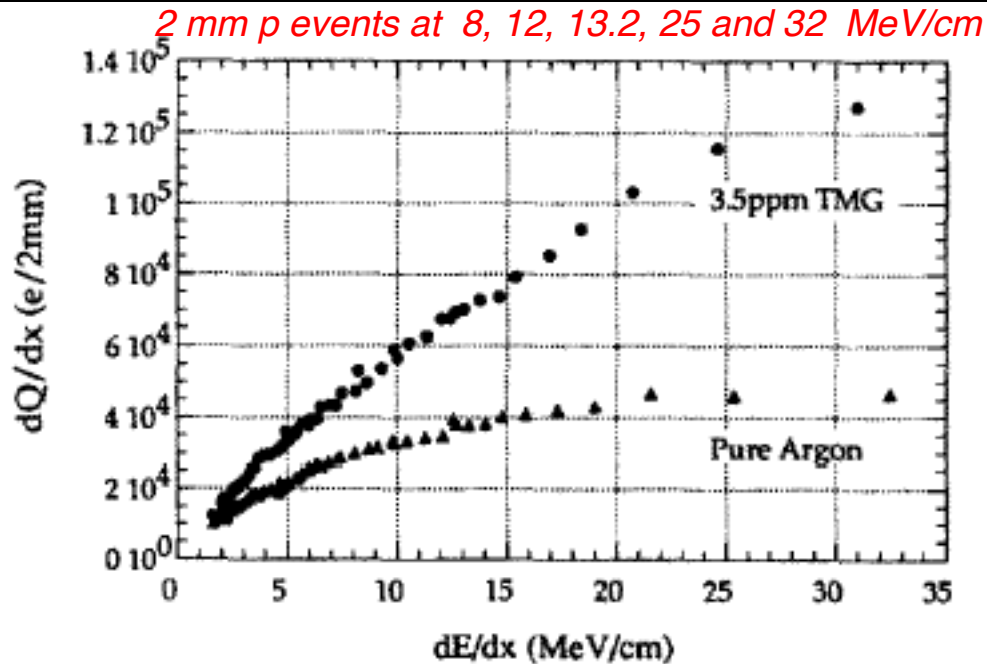
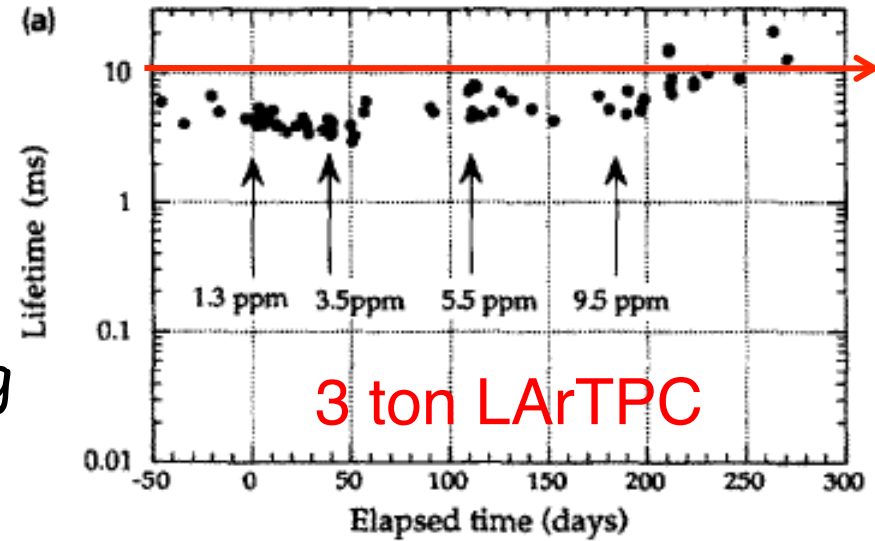

Effects due to positive ions in Argon

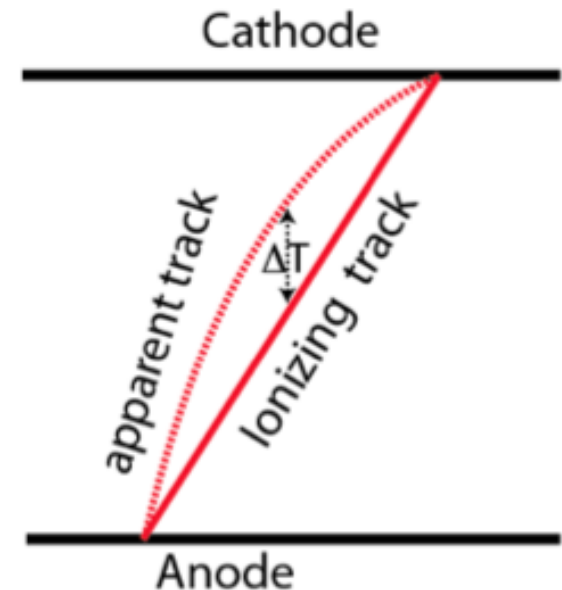

- At shallow depths one has to contend with the presence of intense backgrounds due to cosmic ray muons which have to be separated out from the neutrino signals.
- This background also generates Ar positive ions which flow very slowly toward the cathode with a mobility, $\mu_i \sim 1.6 \cdot 10^{-3} \text{ cm}^2\text{s}^{-1}\text{V}^{-1}$
- With μ_i as here expressed in $(\text{cm}/\text{sec}) / (\text{Volt}/\text{cm})$ — the experimental drift velocity for trapped electrons in pure liquid Argon and for a electric field of 500 Volt/cm is 0.8 cm/s, corresponding to 190 sec LAr drift path for travel of 1.5 m.
- The very long time may produce space charge effects
- *T. DEYt and T. J. LEWIS, "Ion mobility and liquid motion in liquefied argon" BRIT. J. APPL. PHYS. (J. PHYS. D), 1968, SER. 2, VOL. 1. PRINTED IN GREAT BRITAIN*

Effect of the slow LAr ions (tentative)

- Non-negligible distortions of the drift field may arise because of the space charge which must be stabilized with wire grids for larger drift distances
- No additional LAr multiplication at the wire planes is assumed

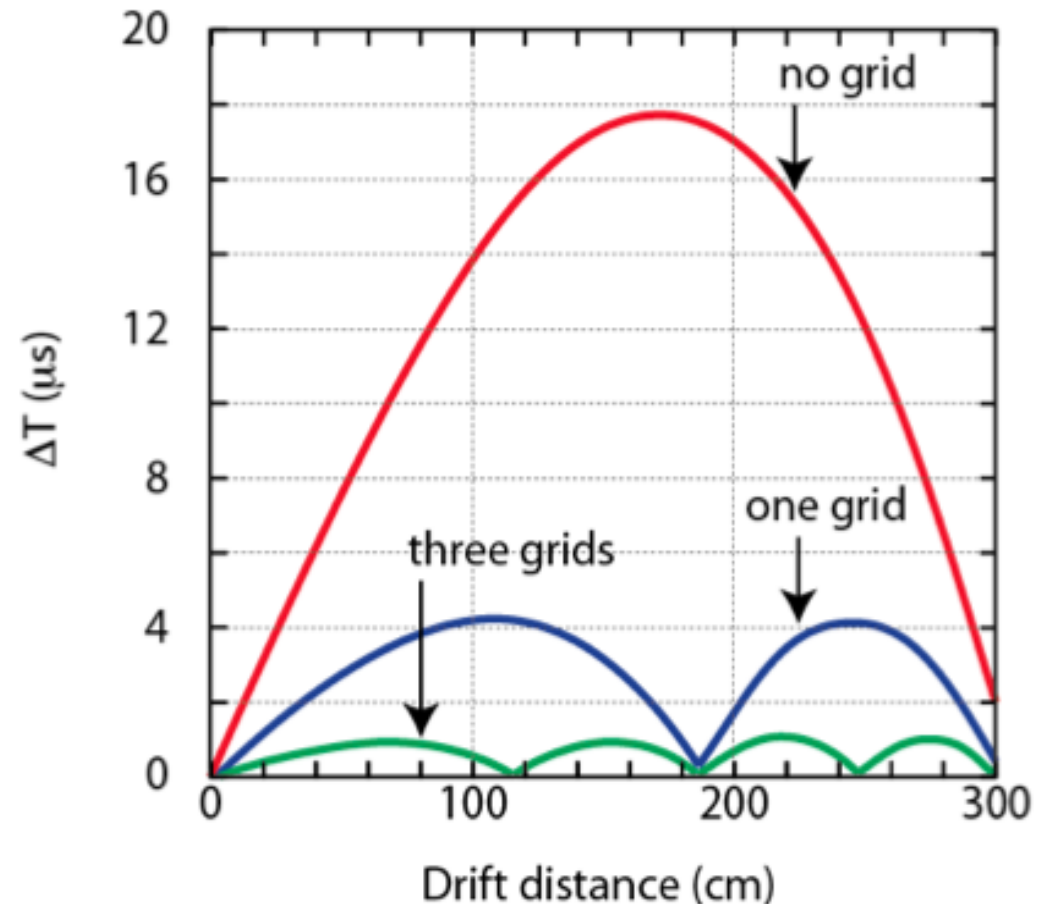
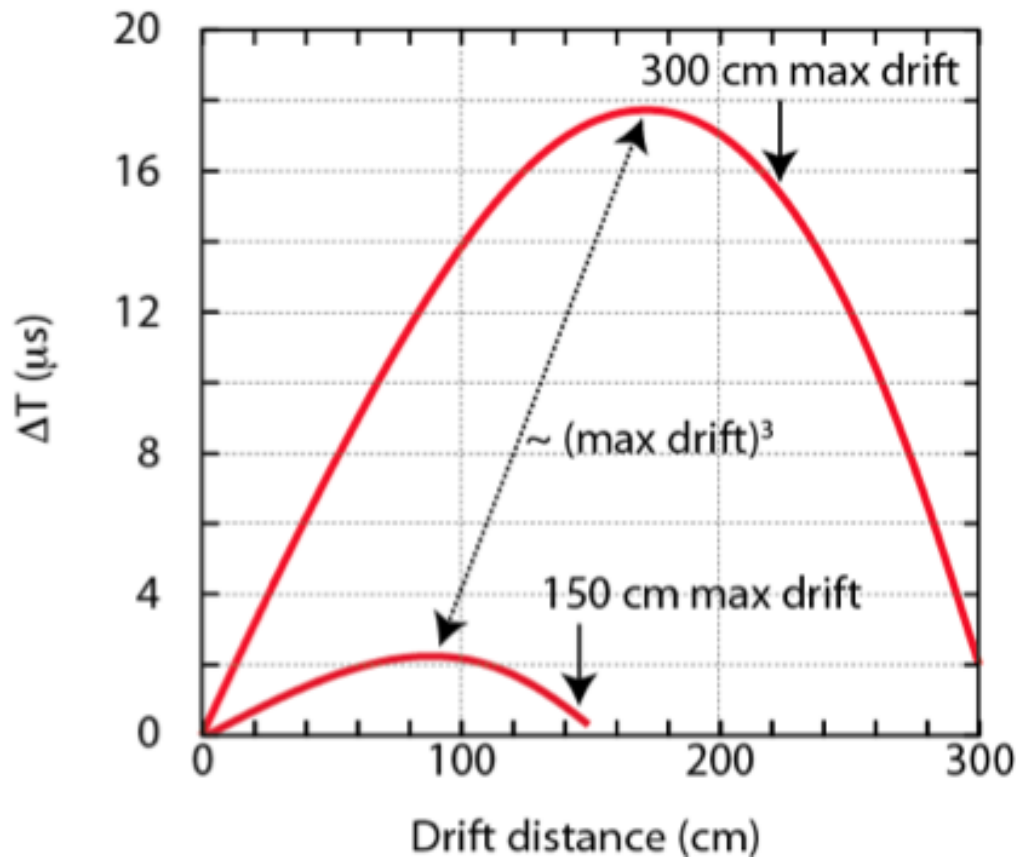

4.- Search of effective ν -e, ν - μ masses with sterile neutrino

- Cosmology and three neutrinos give a very small value for the sum of neutrino masses. Quite independently from the outcome of the NEUTRINO-4 experiment, there is a very solid information about the possible existence of one sterile neutrino m_4 , that ICARUS may be able to observe with L/E over a wide mass range, provided $m_1^2, m_2^2, m_3^2 \ll m_4^2$. $|U_{e4}| = \frac{1}{4} \sin^2(2\theta_{14})$
- Both $m_{\nu\mu}^{\text{eff}}$, and $m_{\nu e}^{\text{eff}}$ masses may be estimated: $m_{\nu e}^{\text{eff}} \approx \text{sqrt}(m_4^2 |U_{e4}|^2) \approx \frac{1}{2} \text{sqrt}(m_4^2 \sin^2(2\theta_{14}))$ and $m_{\nu\mu}^{\text{eff}} \approx \text{sqrt}(m_4^2 |U_{\mu 4}|^2)$.
- This is simply due to the fact that a fraction of the effective sterile mass m_s is mixed to the effective masses of the light neutrinos ν -e and ν - μ .
- A value $m_{\nu e}^{\text{eff}} = (0.58 \pm 0.09)$ eV has been derived from the m_4^2 prediction of NEUTRINO-4 and it does not contradict the upper direct limit of neutrino mass $m_{\nu e}^{\text{eff}} \leq 1.1$ eV (CL 90%) of KATRIN.

Predicting the ν -e effective mass for NEUTRINO-4

COMPARISON WITH EXPERIMENT KATRIN ON MEASUREMENT OF NEUTRINO MASS

$$m_{\nu_e}^{\text{eff}} = \sqrt{\sum m_i^2 |U_{ei}|^2}$$

$$\Delta m_{14}^2 \approx m_4^2, \dots |U_{14}^2| \ll 1$$

Limitations on the sum of mass of active neutrinos $\sum m_\nu = m_1 + m_2 + m_3$ from cosmology are in the range $0.54 \div 0.11 \text{ eV}$

$$m_{\nu_e}^{\text{eff}} \approx \sqrt{m_4^2 |U_{e4}|^2} \approx \frac{1}{2} \sqrt{m_4^2 \sin^2 2\theta_{14}}$$

$$\leftarrow m_1^2, m_2^2, m_3^2, m_4^2$$

$$m_4 = (2.68 \pm 0.13) \text{ eV}$$

$$\sin^2 2\theta_{14} \approx 0.19 \pm 0.04 (4.6\sigma)$$

$$m_{\nu_e}^{\text{eff}} = (0.58 \pm 0.09) \text{ eV}$$

$$\sin^2 2\theta_{14} = 4|U_{14}|^2(1 - |U_{14}|^2)$$

$$|U_{14}^2| \approx \frac{1}{4} \sin^2 2\theta_{14}$$

NEUTRINO -4 RESULTS

$$m_{\nu_e}^{\text{eff}} \leq 1.1 \text{ eV} \quad (\text{CL } 90\%)$$

KATRIN Collaboration. M. Aker et al., Phys. Rev. Lett. 123, 221802 (2019).
arXiv:1909.06048

Conclusions

- The problem of neutrino anomalies has been with us for about $\frac{1}{4}$ of the century.
- The recent NEUTRINO-4 experiment is a major step forward, however still statistically weak, representing only a 2.8σ signal. Further analysis is needed.
- The re-activation of the Fermilab Booster and NUMI beams is expected by the end of 2020, followed by the initial operation of ICARUS in both locations. Definitive and eventually confirming **evidences 1.- and 2** with ν -mu and ν -e are foreseen after a few months.
- After approximately the first year of operation, the SBND L-Ar TPC detector will be added at a shorter distance of the Booster beam to perform a definitive 5σ analysis of sterile neutrinos **in evidence 3.**
- Values of effective light neutrino masses will be calculated as **evidence 4.**



Thank you !

